

## HIGH PRECISION DIGITAL LINEAR GAGES

**IP43**  
WATERPROOF

**ABSOLUTE ENCODER, THE ORIGINAL**  
DATA REMAINS AFTER POWER OFF

**INSPECTION**  
**CERTIFICATE**



7130-10



7130-10L

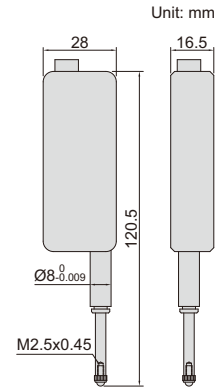

- Scale type: optical grating
- Absolute encoder, the original data remains after power off
- Digital signal output, amplifier is not required
- Repeatability: 0.5µm
- Measuring force: 1.5N
- Dust/waterproof: IP43
- Baud rate: 9600 (can be customized)
- Cable length: 3m (can be customized)

Code	Range	Resolution	Accuracy	Outgoing cable direction	Output signal	Output interface
7130-10	0-12.7mm	0.1µm	1.6µm	horizontal	Rs232, TTL level	
7130-10L	0-12.7mm	0.1µm	1.6µm	vertical	RS232, TTL level	
7130-11	0-12.7mm	0.1µm	1.6µm	horizontal	RS232, 232 level	
7130-11L	0-12.7mm	0.1µm	1.6µm	vertical	RS232, 232 level	
7130-12	0-12.7mm	0.1µm	1.6µm	horizontal	RS485	
7130-12L	0-12.7mm	0.1µm	1.6µm	vertical	RS485	
7130-13	0-12.7mm	0.1µm	1.6µm	horizontal	RS232, TTL level	
7130-13L	0-12.7mm	0.1µm	1.6µm	vertical	RS232, TTL level	
7130-14	0-12.7mm	0.1µm	1.6µm	horizontal	RS232, 232 level	
7130-14L	0-12.7mm	0.1µm	1.6µm	vertical	RS232, 232 level	

## DIAL COMPARATOR

**INSIZE PLUS**  
MADE IN EUROPE

**JEWELLED**  
BEARING

**SHOCK**  
PROOF

**INSPECTION**  
**CERTIFICATE**  
TRACEABLE TO NIST



2881-01

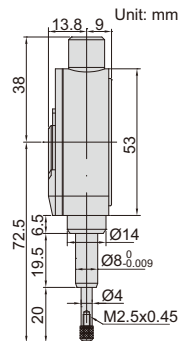

lifting lever (optional)

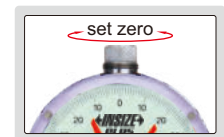
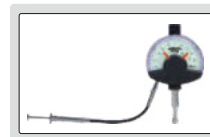

- Meet DIN879-1
- Shockproof
- Jeweled bearing
- Overtravel: 3mm
- Shadow free dial face cover
- Supplied with limit pointers
- Initial measuring force 1.2N
- Optional accessory: lifting lever (code 6289-150)

Code	Range	Graduation	Accuracy	Hysteresis	Dial reading	Remark
2881-01*	0.1mm	0.001mm	1.2µm	0.5µm	50-0-50	flat back

\*Supplied with manufacturer inspection certificate traceable to NIST USA

**INSPECTION  
CERTIFICATE**  
TRACEABLE TO NIST

SHOCK  
PROOF

## HIGH PRECISION COMPACT DIAL INDICATORS

**INSIZE PLUS**  
MADE IN EUROPE

- Shockproof
- Jeweled bearing
- With limit pointers
- Optional accessory:  
backs (page 176~177),  
contact points (page 173~175),  
lifting lever (code 6289-150)

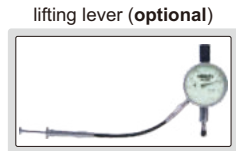

2890-1

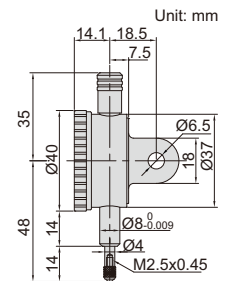

Code	Range	Graduation	Accuracy	Hysteresis	Range/rev	Dial reading	Remark
2890-1*	1mm	0.001mm	3µm	1.5µm	0.1mm	0-100	lug back
2890-1F*	1mm	0.001mm	3µm	1.5µm	0.1mm	0-100	flat back

\*Supplied with manufacturer inspection certificate traceable to NIST USA

**INSPECTION  
CERTIFICATE**  
TRACEABLE TO NIST

SHOCK  
PROOF

## HIGH PRECISION DIAL INDICATORS

**INSIZE PLUS**  
MADE IN EUROPE

- Shockproof
- Jeweled bearing
- With limit pointers
- Optional accessory:  
backs (page 176~177),  
contact points (page 173~175),  
lifting lever (code 6289-150)

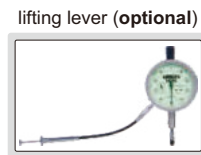

2891-1

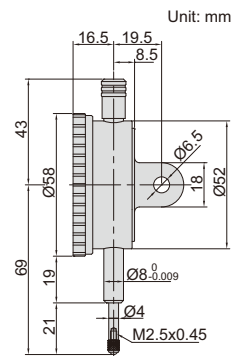

Code	Range	Graduation	Accuracy	Hysteresis	Range/rev	Dial reading	Remark
2891-1*	1mm	0.001mm	3µm	1.5µm	0.1mm	0-100	lug back
2891-1F*	1mm	0.001mm	3µm	1.5µm	0.1mm	0-100	flat back

\*Supplied with manufacturer inspection certificate traceable to NIST USA

**INSPECTION  
CERTIFICATE**  
TRACEABLE TO NIST

SHOCK  
PROOF

JEWELLED  
BEARING

## PRECISION DIAL INDICATORS

**INSIZE PLUS**  
MADE IN EUROPE

- Shockproof
- Jeweled bearing
- With limit pointers
- Optional accessory:  
backs (page 176~177),  
contact points (page 173~175)



2830-1

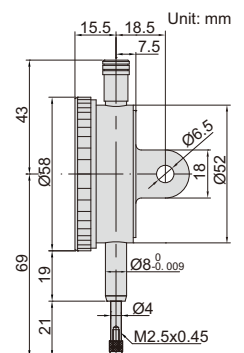

Code	Range	Graduation	Accuracy	Hysteresis	Range/rev	Dial reading	Remark
2830-1*	1mm	0.001mm	5µm	2µm	0.2mm	0-100-0	lug back
2830-1F*	1mm	0.001mm	5µm	2µm	0.2mm	0-100-0	flat back

\*Supplied with manufacturer inspection certificate traceable to NIST USA

## COMPACT DIAL INDICATOR

**INSIZE PLUS**  
MADE IN EUROPE

- Meet DIN878
- With limit pointers
- Optional accessory: backs (page 176~177), contact points (page 173~175)



2886-3F

**INSPECTION CERTIFICATE**  
TRACEABLE TO NIST

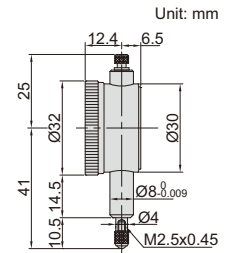

Code	Range	Graduation	Accuracy	Hysteresis	Range/rev	Dial reading	Remark
2886-3F*	3mm	0.01mm	12µm	3µm	0.5mm	0-50	flat back

\*Supplied with manufacturer inspection certificate traceable to NIST USA

7

## COMPACT DIAL INDICATORS

**INSIZE PLUS**  
MADE IN EUROPE

- Meet DIN878
- With limit pointers
- Optional accessory: backs (page 176~177), contact points (page 173~175)



2887-5

**INSPECTION CERTIFICATE**  
TRACEABLE TO NIST

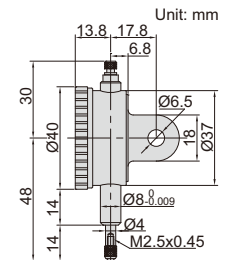

Code	Range	Graduation	Accuracy	Hysteresis	Range/rev	Dial reading	Remark
2887-5*	5mm	0.01mm	14µm	3µm	0.5mm	0-50	lug back
2887-5F*	5mm	0.01mm	14µm	3µm	0.5mm	0-50	flat back

\*Supplied with manufacturer inspection certificate traceable to NIST USA

## LARGE DIAL FACE DIAL INDICATOR

**INSIZE PLUS**  
MADE IN EUROPE

- Large, easy-to-read dial face
- With limit pointers
- Optional accessory: backs (page 176~177), contact points (page 173~175)



2888-10

**INSPECTION CERTIFICATE**  
TRACEABLE TO NIST

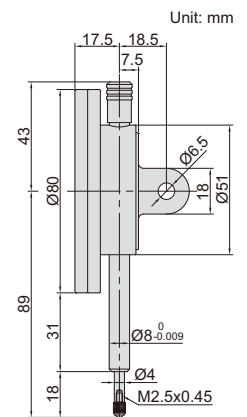

Code	Range	Graduation	Accuracy	Hysteresis	Range/rev	Dial reading	Remark
2888-10*	10mm	0.01mm	17µm	5µm	1mm	0-100	flat back, with spare lug back

\*Supplied with manufacturer inspection certificate traceable to NIST USA



## DIAL INDICATORS

**INSIZE PLUS**  
MADE IN EUROPE

- Meet DIN878
- With limit pointers
- Optional accessory: backs (page 176~177), contact points (page 173~175)



2892-10

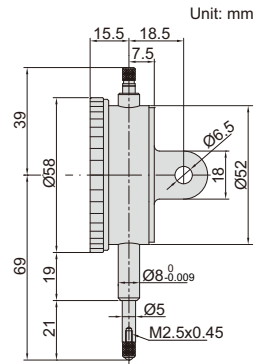

Code	Range	Graduation	Accuracy	Hysteresis	Range/rev	Dial reading	Remark
2892-10 *	10mm	0.01mm	17µm	3µm	1mm	0-100	lug back
2892-10F *	10mm	0.01mm	17µm	3µm	1mm	0-100	flat back

\* Supplied with manufacturer inspection certificate traceable to NIST USA



## BACK PLUNGER DIAL INDICATOR

**INSIZE PLUS**  
MADE IN EUROPE

- With limit pointers
- Optional accessory: contact points (page 173~175)



2893-3

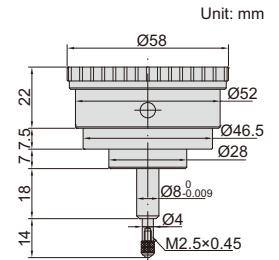

Code	Range	Graduation	Accuracy	Hysteresis	Range/rev	Dial reading
2893-3 *	3mm	0.01mm	15µm	5µm	1mm	0-100

\* Supplied with manufacturer inspection certificate traceable to NIST USA



## WATERPROOF DIAL INDICATOR

**INSIZE PLUS**  
MADE IN EUROPE

- Meet DIN878
- Shockproof
- IP67 dust/waterproof
- With limit pointers
- Optional accessory: contact points (page 173~175)



2894-10F

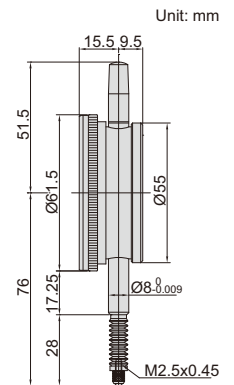

Code	Range	Graduation	Accuracy	Hysteresis	Range/rev	Dial reading	Remark
2894-10F *	10mm	0.01mm	17µm	3µm	1mm	0-100	flat back

\* Supplied with manufacturer inspection certificate traceable to NIST USA

## DIAL INDICATORS (LONG STROKE)

**INSIZE PLUS**  
MADE IN EUROPE

**INSPECTION CERTIFICATE**  
TRACEABLE TO NIST

- With limit pointers
- Optional accessory: backs (page 176~177), contact points (page 173~175)



2889-30

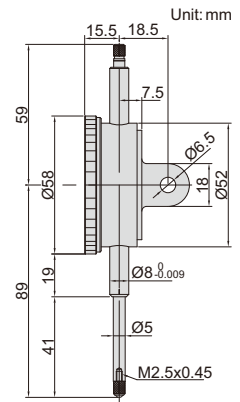

Code	Range	Graduation	Accuracy	Hysteresis	Range/rev	Dial reading	Remark
2889-30 *	30mm	0.01mm	25µm	5µm	1mm	0-100	lug back
2889-30F *	30mm	0.01mm	25µm	5µm	1mm	0-100	flat back

\*Supplied with manufacturer inspection certificate traceable to NIST USA

7

## ONE REVOLUTION PRECISION DIAL INDICATORS

**INSIZE PLUS**  
MADE IN EUROPE

**SHOCK PROOF**

**INSPECTION CERTIFICATE**  
TRACEABLE TO NIST

- Eliminate the possibility of reading errors due to miscounting
- Shockproof
- Jeweled bearing
- Free stroke: 4.5mm
- With limit pointers
- Optional accessory: backs (page 176~177), contact points (page 173~175), lifting lever (code 6289-150)



2885-008

lifting lever (optional)

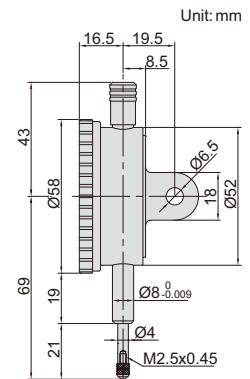

Code	Range	Graduation	Accuracy	Hysteresis	Dial reading	Remark
2885-008 *	0.08mm	0.001mm	3µm	1.5µm	40-0-40	lug back
2885-008F *	0.08mm	0.001mm	3µm	1.5µm	40-0-40	flat back

\*Supplied with manufacturer inspection certificate traceable to NIST USA

## ONE REVOLUTION DIAL INDICATORS

**INSIZE PLUS**  
MADE IN EUROPE

**SHOCK PROOF**

**INSPECTION CERTIFICATE**  
TRACEABLE TO NIST

- Meet DIN878
- Eliminate the possibility of reading errors due to miscounting
- Shockproof
- Free stroke: 7mm
- With limit pointers
- Optional accessory: backs (page 176~177), contact points (page 173~175)



2882-08

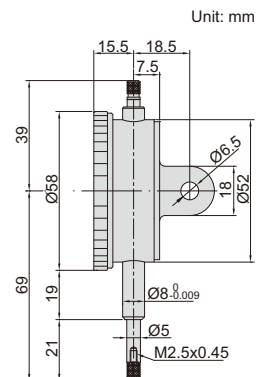

Code	Range	Graduation	Accuracy	Hysteresis	Dial reading	Remark
2882-08 *	0.8mm	0.01mm	9µm	3µm	40-0-40	lug back
2882-08F *	0.8mm	0.01mm	9µm	3µm	40-0-40	flat back

\*Supplied with manufacturer inspection certificate traceable to NIST USA



## PRECISION DIAL INDICATORS

- Graduation: 0.001mm
- Jeweled bearing
- Supplied with limit pointers and bezel clamp
- Optional accessory: backs (page 176~177), contact points (page 173~175)



2313-1A

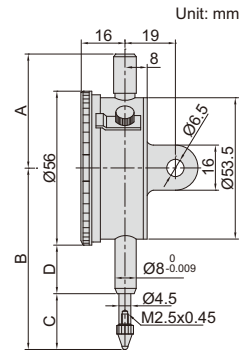

Code	Range	Accuracy	Hysteresis	Range/rev	Dial reading	Remark	A	B	C	D
2313-1FA *	1mm	5µm	2µm	0.2mm	0-100-0	flat back	45	62.5	19.5	15
2313-2FA *	2mm	6µm	2.5µm	0.2mm	0-100-0	flat back	45	62.5	19.5	15
2313-1A *	1mm	5µm	2µm	0.2mm	0-100-0	lug back	45	62.5	19.5	15
2313-2A *	2mm	6µm	2.5µm	0.2mm	0-100-0	lug back	45	62.5	19.5	15

\* Supplied with manufacturer inspection certificate traceable to NIST USA

## COMPACT DIAL INDICATORS

- Meet DIN878
- Jeweled bearing
- Supplied with limit pointers and bezel clamp
- Optional accessory: backs (page 176~177), contact points (page 173~175)



2311-5

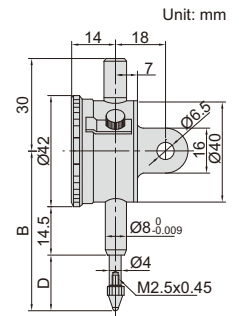

Code	Range	Graduation	Accuracy	Hysteresis	Range/rev	Dial reading	Remark	B	D
2311-3F *	3mm	0.01mm	12µm	3µm	0.5mm	0-50	flat back	46	10.5
2311-5F *	5mm	0.01mm	14µm	3µm	0.5mm	0-50	flat back	48	12.5
2311-3 *	3mm	0.01mm	12µm	3µm	0.5mm	0-50	lug back	46	10.5
2311-5 *	5mm	0.01mm	14µm	3µm	0.5mm	0-50	lug back	48	12.5

\* Supplied with manufacturer inspection certificate traceable to NIST USA

## DIAL INDICATORS (BASIC TYPE)

- Meet DIN878
- Jeweled bearing
- Supplied with limit hands and bezel clamp
- Packed in carton box
- Optional accessory: backs (page 176~177), contact points (page 173~175)



2301-10

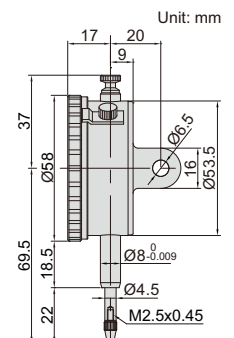

Code	Range	Graduation	Accuracy	Hysteresis	Range/rev	Dial reading	Remark
2301-10F *	10mm	0.01mm	17µm	3µm	1mm	0-100	flat back
2301-10 *	10mm	0.01mm	17µm	3µm	1mm	0-100	lug back with spare flat back

\* Supplied with manufacturer inspection certificate traceable to NIST USA

## DIAL INDICATORS (STANDARD TYPE)

JEWELLED BEARING

**INSPECTION CERTIFICATE**  
TRACEABLE TO NIST

- Meet DIN878
- Jeweled bearing
- Supplied with limit pointers and bezel clamp
- Optional accessory: backs (page 176~177), contact points (page 173~175)



2308-10A

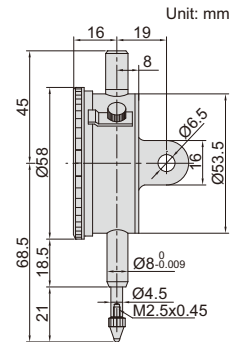

Code	Range	Graduation	Accuracy	Hysteresis	Range/rev	Dial reading	Remark
2308-3FA *	3mm	0.01mm	12µm	3µm	1mm	0-100	flat back
2308-5FA *	5mm	0.01mm	14µm	3µm	1mm	0-100	flat back
2308-10FA *	10mm	0.01mm	17µm	3µm	1mm	0-100	flat back
2308-3A *	3mm	0.01mm	12µm	3µm	1mm	0-100	lug back
2308-5A *	5mm	0.01mm	14µm	3µm	1mm	0-100	lug back
2308-10A *	10mm	0.01mm	17µm	3µm	1mm	0-100	lug back

\*Supplied with manufacturer inspection certificate traceable to NIST USA

## REVERSE READING DIAL INDICATORS

JEWELLED BEARING

**INSPECTION CERTIFICATE**  
TRACEABLE TO NIST

- Meet DIN878
- Suitable for depth and step measurements
- Jeweled bearing
- Supplied with limit pointers and bezel clamp
- Optional accessory: backs (page 176~177), contact points (page 173~175)



2801-10

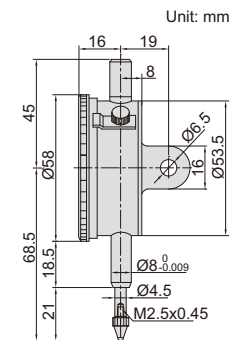

Code	Range	Graduation	Accuracy	Hysteresis	Range/rev	Dial reading	Remark
2801-10F *	10mm	0.01mm	17µm	3µm	1mm	100-0	flat back
2801-10 *	10mm	0.01mm	17µm	3µm	1mm	100-0	lug back

\*Supplied with manufacturer inspection certificate traceable to NIST USA

## SHOCKPROOF DIAL INDICATORS

SHOCK PROOF

JEWELLED BEARING

**INSPECTION CERTIFICATE**  
TRACEABLE TO NIST

- Meet DIN878
- Shockproof
- Jeweled bearing
- Supplied with limit pointers and bezel clamp
- Optional accessory: backs (page 176~177), contact points (page 173~175)



2314-10A

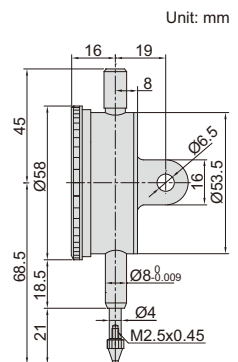

Code	Range	Graduation	Accuracy	Hysteresis	Range/rev	Dial reading	Remark
2314-3FA *	3mm	0.01mm	12µm	3µm	1mm	0-100	flat back
2314-5FA *	5mm	0.01mm	14µm	3µm	1mm	0-100	flat back
2314-10FA *	10mm	0.01mm	17µm	3µm	1mm	0-100	flat back
2314-3A *	3mm	0.01mm	12µm	3µm	1mm	0-100	lug back
2314-5A *	5mm	0.01mm	14µm	3µm	1mm	0-100	lug back
2314-10A *	10mm	0.01mm	17µm	3µm	1mm	0-100	lug back

\*Supplied with manufacturer inspection certificate traceable to NIST USA



## INCH DIAL INDICATORS

- Meet ASME B89.1.10M-2001
- With lug back
- Supplied with limit pointers and bezel clamp



2307-1

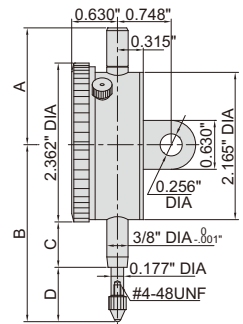

Code	Range	Graduation	Accuracy		Range/rev	Dial reading
			First 2.5 rev	Overall		
2307-025 *	0.25"	0.001"	±0.001"	±0.001"	0.1"	0-100
2307-05 *	0.5"	0.001"	±0.001"	±0.002"	0.1"	0-100
2307-1 *	1"	0.001"	±0.001"	±0.002"	0.1"	0-100
2307-2 *	2"	0.001"	±0.001"	±0.004"	0.1"	0-100
2307-0255 *	0.25"	0.0005"	±0.0005"	±0.0015"	0.05"	0-50
2307-055 *	0.5"	0.0005"	±0.0005"	±0.0015"	0.05"	0-50
2307-105 *	1"	0.0005"	±0.0005"	±0.002"	0.05"	0-50
2307-205 *	2"	0.0005"	±0.0005"	±0.002"	0.05"	0-50

Range	A	B	C	D
0.25"	1.811"	2.953"	0.787"	0.984"
0.5"	1.811"	2.953"	0.787"	0.984"
1"	1.811"	3.346"	0.787"	1.378"
2"	4.370"	5.472"	1.969"	2.323"

\* Supplied with manufacturer inspection certificate traceable to NIST



## WATERPROOF DIAL INDICATORS

- Meet DIN878
- IP54 dust/waterproof
- With limit pointers
- Optional accessory: backs (page 176~177), contact points (page 173~175)



2324-10A

Code	Range	Graduation	Accuracy	Hysteresis	Range/rev	Dial reading	Remark
2324-10FA *	10mm	0.01mm	17µm	3µm	1mm	0-100	flat back
2324-10A *	10mm	0.01mm	17µm	3µm	1mm	0-100	lug back

\* Supplied with manufacturer inspection certificate traceable to NIST USA

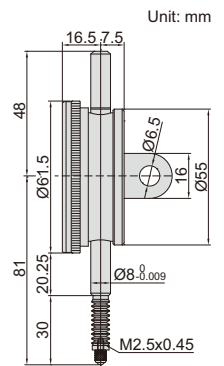

## DOUBLE FACE DIAL INDICATOR

- Meet DIN878
- Read from both sides
- Jeweled bearing
- Supplied with limit pointers
- Optional accessory: contact points (page 173~175)



front

back

2328-10

Code	Range	Graduation	Accuracy	Hysteresis	Range/rev	Dial reading
2328-10 *	10mm	0.01mm	17µm	3µm	1mm	0-100

\* Supplied with manufacturer inspection certificate traceable to NIST USA

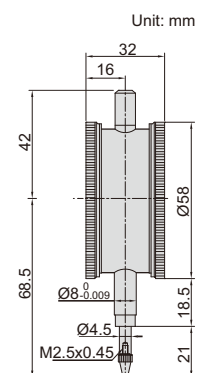



## DIAL INDICATORS (LONG STROKE)



2310-30A

- Supplied with limit pointers and bezel clamp
- Optional accessory: backs (page 176~177), contact points (page 173~175)

(mm)

Code	Range	Graduation	Accuracy	Hysteresis	Range/rev	Dial reading	Remark	B	D
2310-20FA *	20mm	0.01mm	25µm	5µm	1mm	0-100	flat back	83	35
2310-30FA *	30mm	0.01mm	35µm	7µm	1mm	0-100	flat back	88	40
2310-20A *	20mm	0.01mm	25µm	5µm	1mm	0-100	lug back	83	35
2310-30A *	30mm	0.01mm	35µm	7µm	1mm	0-100	lug back	88	40

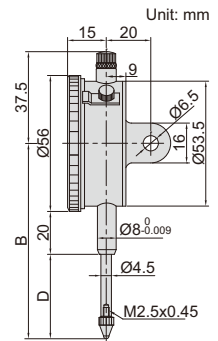

\*Supplied with manufacturer inspection certificate traceable to NIST USA

## DIAL INDICATORS (LONG STROKE, BASIC TYPE)



2302-25

- Supplied with limit pointers and bezel clamp
- Packed in carton box
- Optional accessory: backs (page 176~177), contact points (page 173~175)

carton box



Code	Range	Graduation	Accuracy	Hysteresis	Range/rev	Dial reading	Remark
2302-25F *	25mm	0.01mm	35µm	7µm	1mm	0-100	flat back
2302-25 *	25mm	0.01mm	35µm	7µm	1mm	0-100	lug back with spare flat back

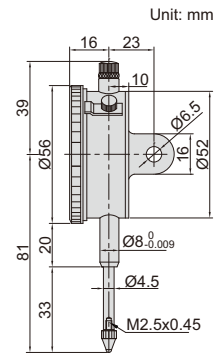

\*Supplied with manufacturer inspection certificate traceable to NIST USA

## DIAL INDICATORS (GRADUATION 0.1mm)



2318-30

- Supplied with limit pointers and bezel clamp
- Optional accessory: backs (page 176~177), contact points (page 173~175)

(mm)

Code	Range	Graduation	Accuracy	Hysteresis	Range/rev	Dial reading	Remark	B	D
2318-10F	10mm	0.1mm	40µm	20µm	10mm	0-10	flat back	70	20
2318-20F	20mm	0.1mm	50µm	20µm	10mm	0-10	flat back	85	35
2318-25F	25mm	0.1mm	60µm	20µm	10mm	0-10	flat back	85	35
2318-30F	30mm	0.1mm	60µm	20µm	10mm	0-10	flat back	90	40
2318-10	10mm	0.1mm	40µm	20µm	10mm	0-10	lug back	70	20
2318-20	20mm	0.1mm	50µm	20µm	10mm	0-10	lug back	85	35
2318-25	25mm	0.1mm	60µm	20µm	10mm	0-10	lug back	85	35
2318-30	30mm	0.1mm	60µm	20µm	10mm	0-10	lug back	90	40

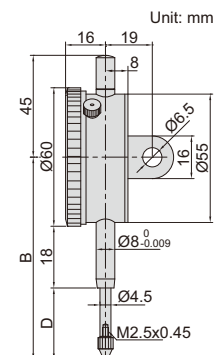

## ONE REVOLUTION DIAL INDICATORS

- Meet DIN878
- Eliminate the possibility of reading errors due to miscounting
- Shockproof
- Supplied with limit pointers
- Optional accessory: backs (page 176~177), contact points (page 173~175)



2316-05

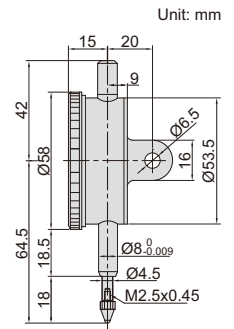

Code	Range	Dial indicator stroke	Graduation	Accuracy	Hysteresis	Dial reading	Remark
2316-05F *	0.5mm	5mm	0.01mm	9µm	3µm	25-0-25	flat back
2316-1F *	1mm	5mm	0.01mm	9µm	3µm	50-0-50	flat back
2316-05 *	0.5mm	5mm	0.01mm	9µm	3µm	25-0-25	lug back
2316-1 *	1mm	5mm	0.01mm	9µm	3µm	50-0-50	lug back

\* Supplied with manufacturer inspection certificate traceable to NIST USA

## DIAL INDICATORS (LONG STROKE)

- Shockproof
- Jeweled bearing
- Supplied with limit pointers
- Optional accessory: backs (page 176~177), contact points (page 173~175)



2309-50

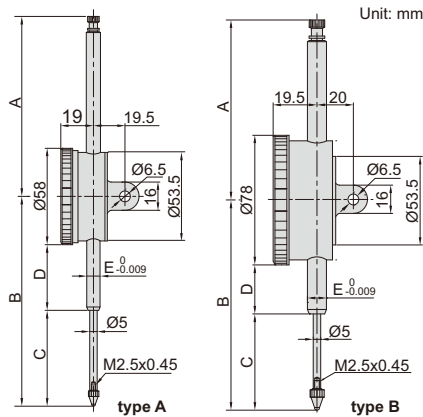

stem clamp Ø10mm for 2309-100D



back of type B



Code	Type	A	B	C	D	E	(mm)
2309-30F *	A	37.5	89.5	40.9	19.5	Ø8	
2309-30 *	A	37.5	89.5	40.9	19.5	Ø8	
2309-50 *	A	108.3	126.2	57.7	39.5	Ø8	
2309-50D *	B	108.3	126.2	57.7	29.5	Ø8	
2309-80	A	138.4	168.4	88	51.3	Ø8	
2309-80D	B	138.4	168.4	88	41.3	Ø8	
2309-100D	B	167.6	207.8	108	60.8	Ø10	

Code	Range	Graduation	Type	Accuracy	Hysteresis	Range/rev	Dial reading	Remark
2309-30F *	30mm	0.01mm	A	35µm	7µm	1mm	0-100	flat back
2309-30 *	30mm	0.01mm	A	35µm	7µm	1mm	0-100	lug back
2309-50 *	50mm	0.01mm	A	40µm	8µm	1mm	0-100	flat back with spare lug back
2309-50D *	50mm	0.01mm	B	40µm	8µm	1mm	0-100	flat back with spare lug back
2309-80	80mm	0.01mm	A	50µm	9µm	1mm	0-100	flat back with spare lug back
2309-80D	80mm	0.01mm	B	50µm	9µm	1mm	0-100	flat back with spare lug back
2309-100D	100mm	0.01mm	B	50µm	9µm	1mm	0-100	flat back with spare lug back

Note: 1) 2309-80, 2309-80D and 2309-100D can only be used vertically  
 2) 2309-100D is supplied with stem clamp Ø10mm for magnetic stands (code 6200-60, 6201-60, 6202-80, 6202-100)  
 3) 2309-30 and 2309-30F can not accept optional backs (page 176~177)

\* Supplied with manufacturer inspection certificate traceable to NIST USA

## INCH LONG STROKE DIAL INDICATORS

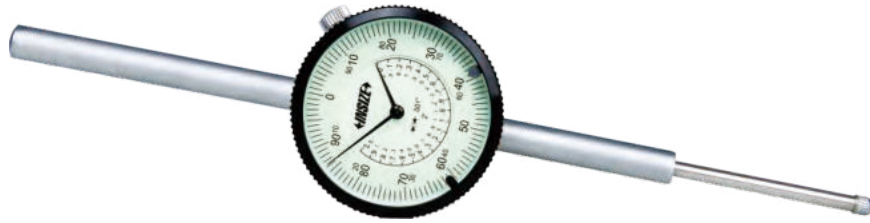

2326-2

- Graduation 0.001"
- With lug back
- Supplied with limit pointers and bezel clamp

Code	Range	Accuracy		Range/rev	Dial reading
		First 2.5 rev	Overall		
2326-2 *	2"	±0.001"	±0.004"	0.1"	0-100
2326-3 **	3"	±0.001"	±0.005"	0.1"	0-100
2326-4 **	4"	±0.001"	±0.005"	0.1"	0-100

\* Supplied with manufacturer inspection certificate traceable to NIST

\*\* 2326-3 and 2326-4 can only be used vertically

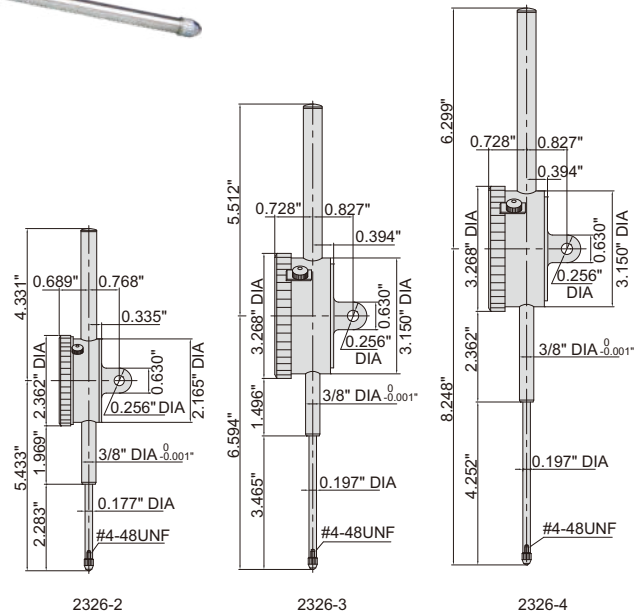

## BALL POINTS



6282-0101

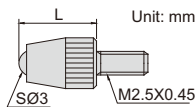

Code	Material of measuring face	L (mm)
6282-0101	carbide	7.3
6282-0103	ceramic	7.3
6282-0104	carbide	8.3
6282-0106	carbide	12.1
6282-0107	carbide	14
6282-0108	carbide	15
6282-0109	ceramic	15
6282-0110	carbide	17

Code	Material of measuring face	L (mm)
6282-0111	carbide	19.3
6282-0112	carbide	20
6282-0113	ceramic	20
6282-0114	carbide	22
6282-0115	carbide	25
6282-0116	ceramic	25
6282-0117	carbide	30
6282-0118	ceramic	30



6282-0301

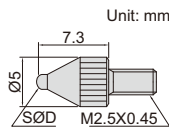

Code	Material of measuring face	SØD (mm)
6282-0301	steel	1
6282-0302	carbide	1.5
6282-0303	carbide	1.8

Code	Material of measuring face	SØD (mm)
6282-0304	carbide	2.5
6282-0305	carbide	4

## SHELL TYPE POINTS



6282-0202

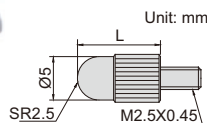

Code	Material of measuring face	L (mm)
6282-0202	steel	5
6282-0203	steel	10
6282-0205	steel	15

Code	Material of measuring face	L (mm)
6282-0207	steel	20
6282-0208	steel	25
6282-0210	steel	30

## SPHERICAL POINT



6282-0401

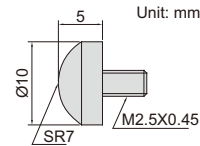

Code	Material of measuring face
6282-0401	steel

## CONICAL POINTS

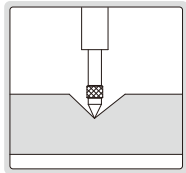

6282-0601



6282-0701



6282-0801



6282-0901

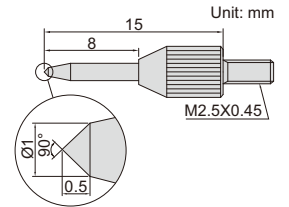
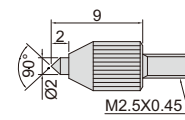
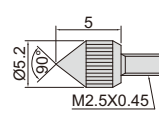
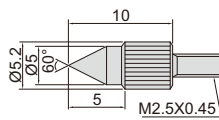

Code	Material of measuring face
6282-0601	steel
6282-0701	steel
6282-0801	steel
6282-0901	steel

## FLAT POINTS



6282-1101

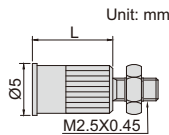

6282-1201

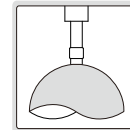
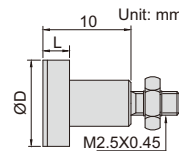

6282-1301

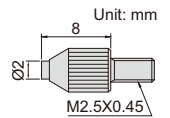

Code	Material of measuring face	L (mm)
6282-1101	steel	8
6282-1102	steel	10

Code	Material of measuring face	ØD	L
6282-1201	steel	10mm	3mm
6282-1202	steel	15mm	4mm
6282-1203	steel	20mm	3mm
6282-1204	steel	25mm	4mm
6282-1205	steel	30mm	4mm

Code	Material of measuring face
6282-1301	carbide

## NEEDLE POINTS

Code	Material of measuring face	ØD	L
6282-1701	steel	0.45	3
6282-1702	steel	0.45	5
6282-1703	carbide	1	3
6282-1704	carbide	1	5
6282-1705	carbide	1	8
6282-1706	carbide	1	10
6282-1707	carbide	1	20
6282-1708	carbide	1	40
6282-1709	carbide	1.5	5

Code	Material of measuring face	ØD	L
6282-1710	carbide	1.5	10
6282-1711	carbide	1.5	13
6282-1712	carbide	1.5	20
6282-1713	carbide	1.5	40
6282-1714	carbide	2	8
6282-1715	carbide	2	18
6282-1716	carbide	2	28
6282-1717	carbide	2	40



6282-1711

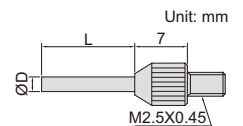

Code	Material of measuring face	L1	L	SR	Ød
6282-1601	steel	11	15	0.4	2
6282-1602	steel	13	17	0.2	2
6282-1603	steel	21	25	0.4	3
6282-1604	steel	31	35	0.4	3



6282-1601

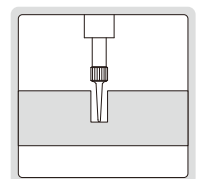
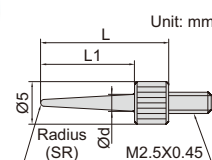

## KNIFE EDGE POINT

Code	Material of measuring face
6282-1001	steel



6282-1001

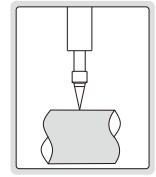
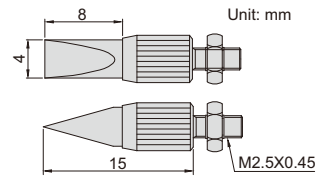

## BLADE POINTS

7

Code	Material of measuring face	D	W
6282-1801	steel	0.4mm	2mm
6282-1802	steel	0.6mm	2mm
6282-1803	steel	1mm	4mm



6282-1801

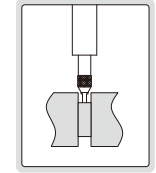
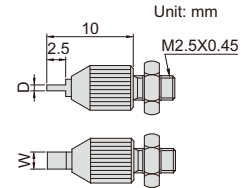

## ROLLER POINT

Code	Material of measuring face
6282-1901	steel



6282-1901

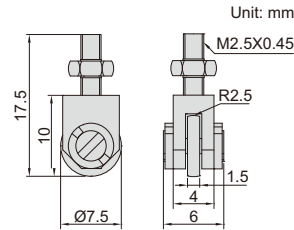

## EXTENSION RODS

Code	Material	L (mm)
6282-2001	steel	10
6282-2002	steel	15
6282-2003	steel	20
6282-2004	steel	25
6282-2005	steel	30
6282-2006	steel	35
6282-2007	steel	40
6282-2008	steel	45
6282-2009	steel	50

Code	Material	L (mm)
6282-2010	steel	55
6282-2011	steel	60
6282-2012	steel	65
6282-2013	steel	70
6282-2014	steel	75
6282-2015	steel	80
6282-2016	steel	90
6282-2017	steel	100



6282-2010

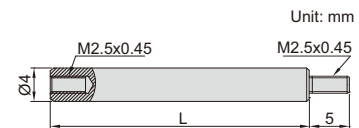

## POINT SET



6282-S6

Code	Material of measuring face
6282-S6	steel

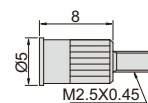

Flat Point

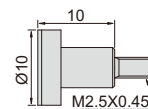

Flat Point

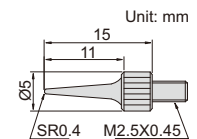

Needle Point

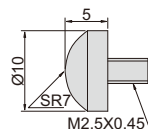

Spherical Point

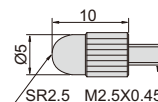

Shell Type Point

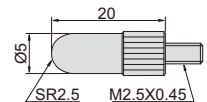

Shell Type Point